

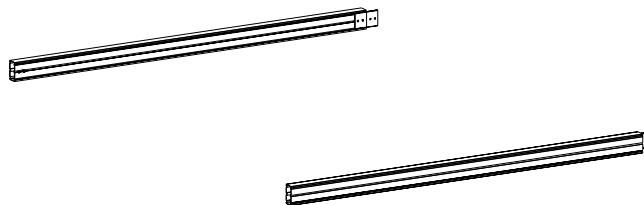

## Monteringsvejledning











MODEL: SCANDIC IDUN 6,2 EXT

MÅL : 200 x 306

ALUMINIUM SOKKEL

Læs hele vejledningen før montering

DEL	NR.	STK.	DEL	NR.	STK.
 2004mm	DJ03	2	 Ø5X40	Z13	4
	D74	2	 M6X10	S14	8
	D75	4	 M6	M03	12
 Φ6X16X1	H79	4	 TSM6X14	S16	4
	D76	4			

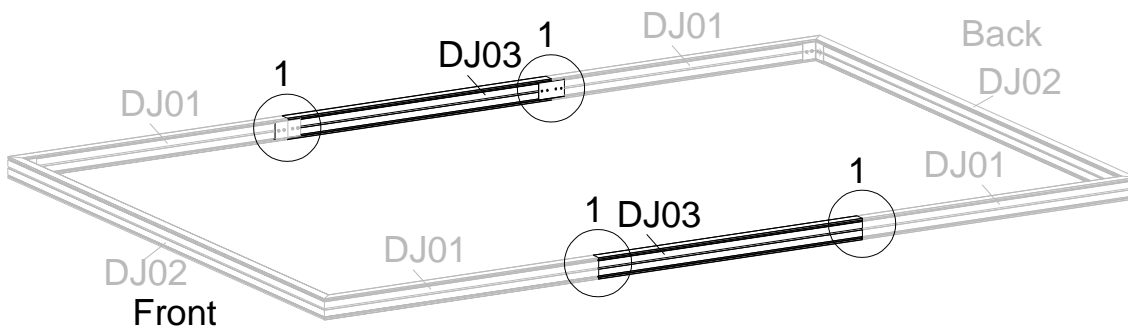

Saml DJ03 med DJ01 ved hjælp af D74, spænd fast med S14 og M03.

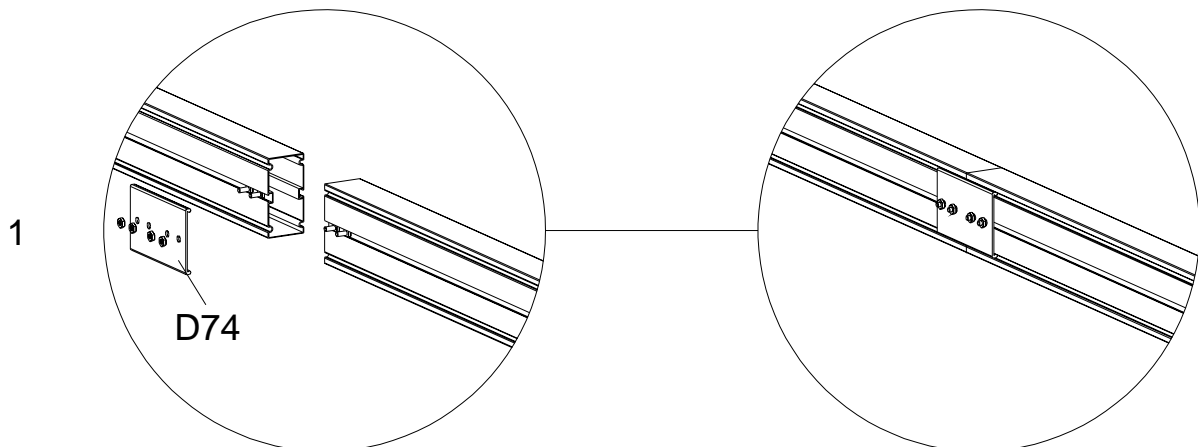

Placer først profilerne, saml med samle- og ankerbeslagene.  
Spænd derefter med medfølgende bolte og møtrikker.

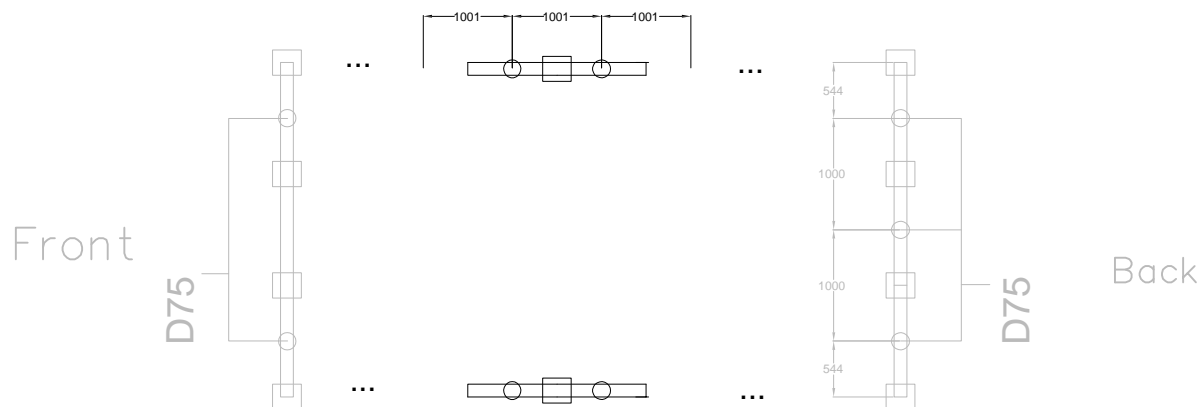

Tegningen viser D75 & D76's placering  
midt for hver glas/polycarbonatpanel.

## SCANDIC IDUN 6,2 EXT.

